

Nur Teile mit Positionsnummer sind als Ersatzteil erhältlich.
Muss die Anlagenfunktion sicher gewährleistet werden, empfehlen wir einen Standby-Kompressor.

Only parts bearing an item number are available as spare part.
In case the installation function must be ensured, we recommend a standby compressor.

Seulement les pièces portant un numéro de position sont disponible comme pièce de rechange.
Si la fonction de l'installation doit être garantie, nous recommandons un compresseur en stand-by.

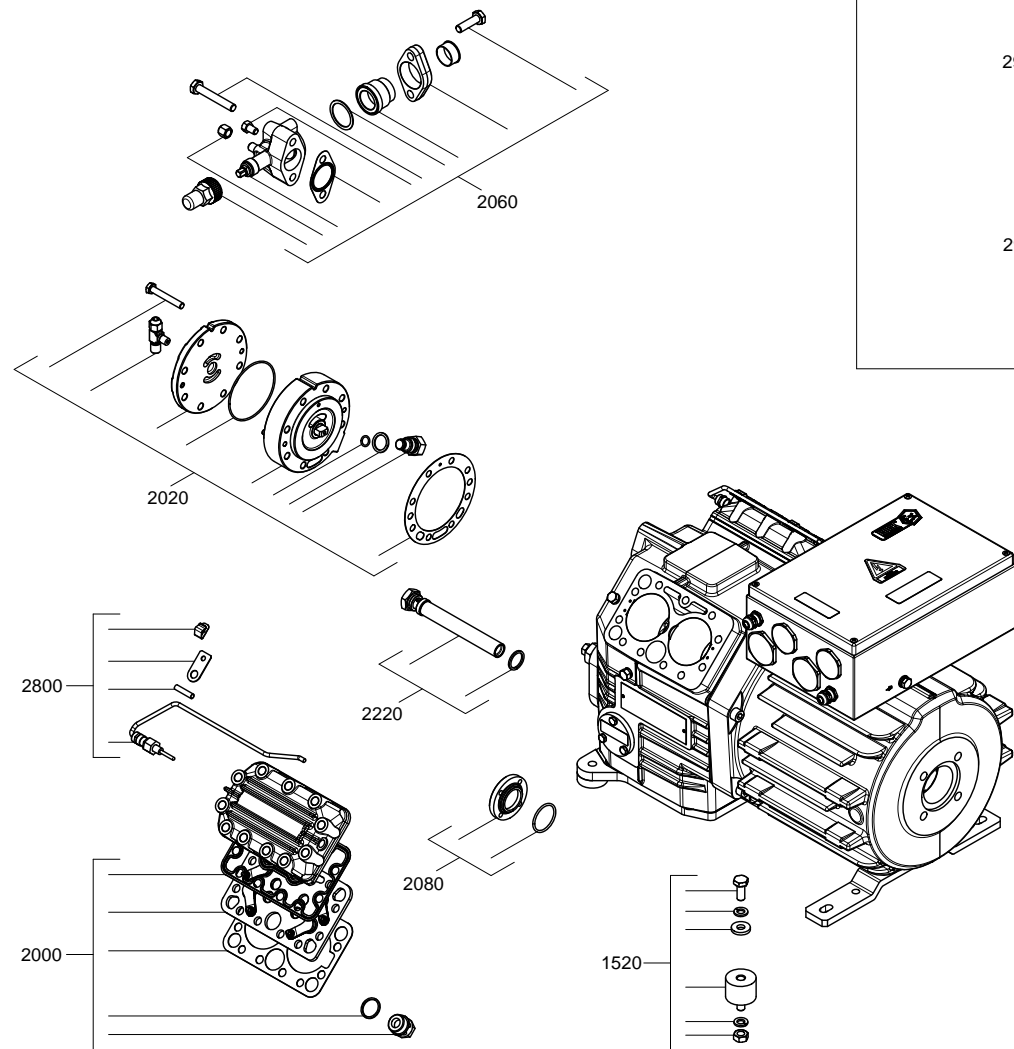

*)Komponenten für Schaltschrankbau außerhalb des explosiven Bereiches.

*)Components to be fitted into the switchboard beyond the explosive area.

*)Composants pour le montage dans l'armoire de distribution de dehors du domaine explosif.

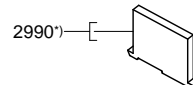
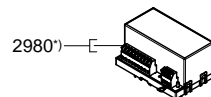

Zubehör / Accessories / Accessoires

Alle BOCK Zubehörsätze sind für den Betrieb in Gerätekategorie 2 nach Richtlinie 94/9/EG zugelassen.

All BOCK accessory kits are approved for operation in device category 2 as per directive 94/9/EC.

Tous les jeux d'accessoires BOCK sont admissible pour l'opération à la catégorie d'appareils 2 selon directive 94/9/CE.

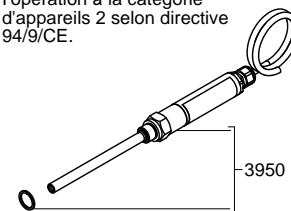

Ölumpfheizung incl. 3m Zuleitung.
Oil sump heater incl. 3 meter input lead.
Resistance de carter avec conduite d'amenée de 3 mètre.

Leistungsregulierung
Capacity regulator
Regulation de puissance

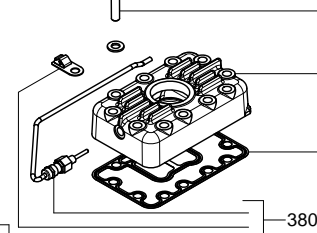
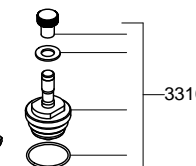
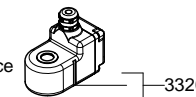

3305

3800

EX-HG(X)4/650-4 +S

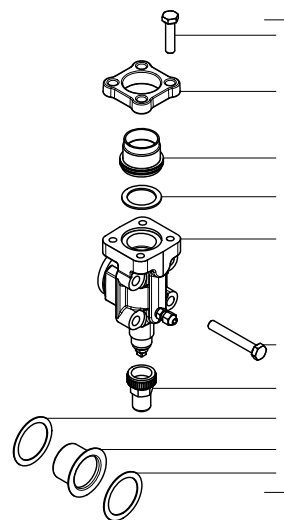

EX-HG(X)4/465+555-4 +S

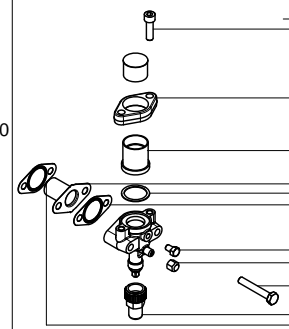

Öldrucküberwachung incl. 3m Zuleitung.
Oil pressure monitoring incl. 3 meter input lead.
Contrôle de la pression d'huile avec conduite d'amenée de 3 mètre.

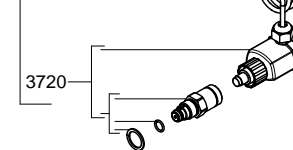
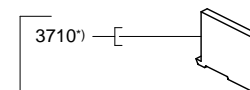

2070

2070

3700

3720



Halbhermetischer Verdichter EX-HG / Semi-hermetic compressor EX-HG / Compresseur semi-hermétique EX-HG

Typ	Teile Nr.	Typ	Teile Nr.	Typ	Teile Nr.
EX-HG4/465-4	17048	EX-HG4/555-4	17050	EX-HG4/650-4	17052
EX-HG4/465-4 S	17049	EX-HG4/555-4 S	17051	EX-HG4/650-4 S	17053
EX-HGX4/465-4	17058	EX-HGX4/555-4	17060	EX-HGX4/650-4	17062
EX-HGX4/465-4 S	17059	EX-HGX4/555-4 S	17061	EX-HGX4/650-4 S	17063



Zeichn.-Nr. / Drawing no. / Numéro de plan:

1.0850-17053.0 0q

Stand / As of date / État: 07.14