

**Zubehör /
Accessories**

Wellenendeteile
Parts for shaft end

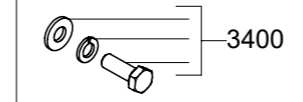

Ölsumpheizung
Oil sump heater

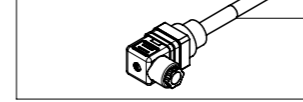

Schwungrad
Flywheel

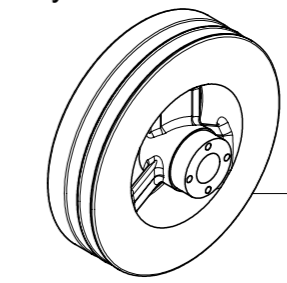

Elektromagnetische Kupplung
Electromagnetic clutch

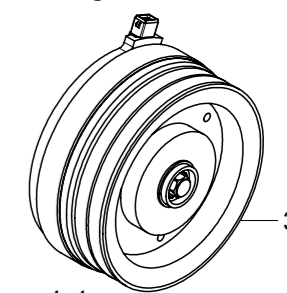

Wärmeschutzthermostat
Thermal protective thermostate

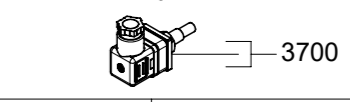

FKX30/235 N+K+TK

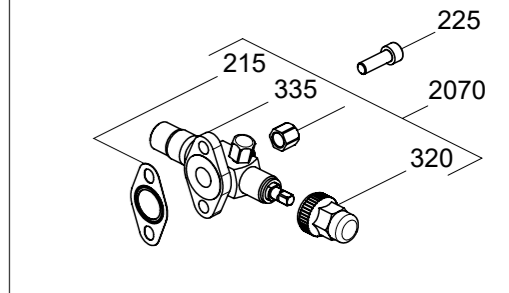

Bis Ausführungsschlüssel 026
Until version code 026

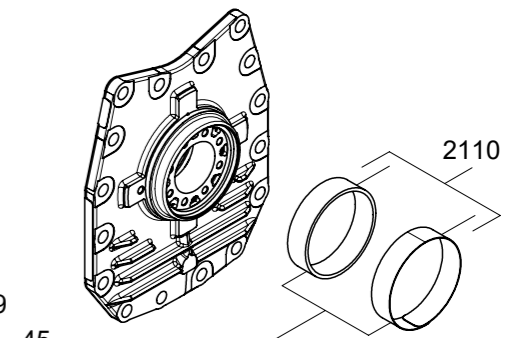

Fahrzeugverdichter / Vehicle Compressor

Typ / type	Teile-Nr. / part-no.	Typ / type	Teile-Nr. / part-no.	Typ / type	Teile-Nr. / part-no.
FKX30/235 N	13971	FKX30/235 K	13972 **	FKX30/235 TK	14336
FKX30/275 N	13973 **	FKX30/275 K	13974 **	FKX30/275 TK	14337
FKX30/325 N	13975 **	FKX30/325 K	13976 **	FKX30/325 TK	14338
** Keine Serie / No series					

Zeichn.-Nr. / Drawing-no.:

1.0851-14338.0 0b

Stand / As of date: 06.23

BOCK[®]

colour the world of tomorrow